

IEG1-1-72-25.0-Q-91-V

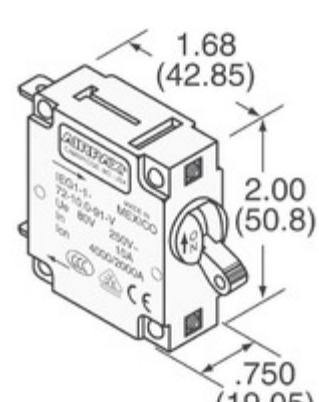

Obrázky jsou pouze orientační.
Podrobné informace o produktu naleznete v části Technické údaje produktu.
Koupit IEG1-1-72-25.0-Q-91-V s důvěrou od Component-World.HK, 1 rok záruka



Part Number: [IEG1-1-72-25.0-Q-91-V](#)
Výrobce: [Sensata Technologies, Airpax](#)
Popis: CIR BRKR MAG-HYDR LEVER 25A
Datový list: [IEG, IUG, JEG, CEG, LEG Series Datasheet](#)

RoHS Status: Bez olova / V souladu RoHS
Ship From: Hong Kong
Shipment Way: DHL/Fedex/TNT/UPS/EMS

[Request For Quotation](#)















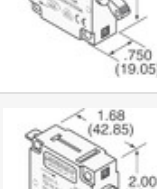
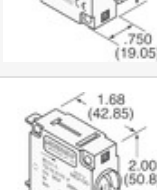

PARAMETR PRODUKTU

Part Number	IEG1-1-72-25.0-Q-91-V	Výrobce	Sensata Technologies, Airpax
Popis	CIR BRKR MAG-HYDR LEVER 25A	Stav volného vedení / RoHS	Bez olova / V souladu RoHS
Dostupné množství	2021 pcs	Datový list	IAG, IUG, JEG, CEG, LEG Series Datasheet
Kategorie	Ochrana obvodu	Série	IEG
Počet pólu	1	Typ montáže	Panel Mount
Úroveň citlivosti na vlhkost (MSL)	1 (Unlimited)	Výrobní standardní doba výroby	6 Weeks
Stav volného vedení / RoHS	Lead free / RoHS Compliant	Osvětlení napětí (nominální)	-
Osvětlení	-	Jmenovitá hodnota proudu	30A
Breaker Typ	Magnetic (Hydraulic Delay)	Pohon Type	Lever

Component-World.com je spolehlivý distributor elektronických součástek. Specializujeme se na všechny elektronické komponenty řady Sensata Technologies, Airpax. Máme 2021 kusy Sensata Technologies, Airpax IEG1-1-72-25.0-Q-91-V na skladě dostupných. Vyžádejte si citát z distributora součástí elektroniky na Component-World.com, náš prodejní tým vás bude kontaktovat do 24 hodin.

RFQ Email: info@Components-World.com

SOUVISEJÍCÍ PRODUKTY

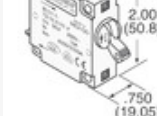
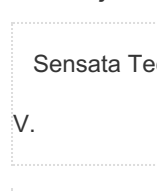
	Část#: IEG1-1-72-20.0-A-01-V Výrobci: Sensata Technologies, Airpax Popis: CIR BRKR MAG-HYDR LEVER 20A	Dotaz
	Část#: IEG1-1-72-5.00-A-21-V Výrobci: Sensata Technologies, Airpax Popis: CIR BRKR MAG-HYDR LEVER 5A	Dotaz
	Část#: IEG1-1-73-20.0-91-V Výrobci: Sensata Technologies, Airpax Popis: CIR BRKR MAG-HYDR	Dotaz
	Část#: IEG1-1-72-15.0-A-21-V Výrobci: Sensata Technologies, Airpax Popis: CIR BRKR MAG-HYDR LEVER 15A	Dotaz
	Část#: IEG1-1-72-20.0-01-V Výrobci: Sensata Technologies, Airpax Popis: CIR BRKR MAG-HYDR LEVER 20A	Dotaz
	Část#: IEG1-1-72-25.0-91-V Výrobci: Sensata Technologies, Airpax Popis: CIR BRKR 25A 250VAC 80VDC	Dotaz
	Část#: IEG1-1-72-20.0-Q-91-V Výrobci: Sensata Technologies, Airpax Popis: CIR BRKR MAG-HYDR LEVER 20A	Dotaz
	Část#: IEG1-1-72-20.0-91-V Výrobci: Sensata Technologies, Airpax Popis: CIR BRKR 20A 250VAC 80VDC	Dotaz
	Část#: IEG1-1-72-30.0-Q-91-V Výrobci: Sensata Technologies, Airpax Popis: CIR BRKR MAG-HYDR LEVER 30A	Dotaz
	Část#: IEG1-1-72-5.00-Q-91-V Výrobci: Sensata Technologies, Airpax Popis: CIR BRKR MAG-HYDR 5A LEVER	Dotaz
	Část#: IEG1-1-73-15.0-91-V Výrobci: Sensata Technologies, Airpax Popis: CIR BRKR MAG-HYDR LEVER 15A	Dotaz
	Část#: IEG1-1-72-25.0-A-01-V Výrobci: Sensata Technologies, Airpax Popis: CIR BRKR MAG-HYDR	Dotaz
	Část#: IEG1-1-72-5.00-C-01-V Výrobci: Sensata Technologies, Airpax Popis: CIR BRKR MAG-HYDR	Dotaz
	Část#: IEG1-1REC4-27269-8 Výrobci: Sensata Technologies, Airpax Popis: CIR BRKR MAG-HYDR LEVER	Dotaz
	Část#: IEG1-1-72-25.0-01-V Výrobci: Sensata Technologies, Airpax Popis: CIR BRKR 25A 250VAC 80VDC	Dotaz
	Část#: IEG1-1-72-15.0-Q-91-V Výrobci: Sensata Technologies, Airpax Popis: CIR BRKR MAG-HYDR 15A LEVER	Dotaz
	Část#: IEG1-1-72-30.0-91-V Výrobci: Sensata Technologies, Airpax Popis: CIR BRKR 30A 250VAC 80VDC	Dotaz
	Část#: IEG1-1-72-8.00-91-V Výrobci: Sensata Technologies, Airpax Popis: CIR BRKR MAG-HYDR	Dotaz
	Část#: IEG1-1REC4-30760-1-V Výrobci: Sensata Technologies, Airpax Popis: CIRCUIT BREAKER MAG-HYDR LEVER	Dotaz
	Část#: IEG1-1-72-20.0-A-21-V Výrobci: Sensata Technologies, Airpax Popis: CIR BRKR MAG-HYDR LEVER 20A	Dotaz

Související klíčová slova pro IEG1-1-72-25.0-Q-91-V

Sensata Technologies, Airpax IEG1-1-72-25.0-Q-91-V	IEG1-1-72-25.0-Q-91-V distributor	IEG1-1-72-25.0-Q-91-V dodavatel	IEG1-1-72-25.0-Q-91-V Cena
V.	IEG1-1-72-25.0-Q-91-V Stáhnout datasheet.	IEG1-1-72-25.0-Q-91-V Datasheet.	IEG1-1-72-25.0-Q-91-V Stock.
koupit IEG1-1-72-25.0-Q-91-V.	Sensata Technologies, Airpax IEG1-1-72-25.0-Q-91-V	Sensata Technologies/Airpax IEG1-1-72-25.0-Q-91-V	
	V.	V.	